

Installation Instructions

Toyota Land Cruiser 100 / Lexus LX 470 Transfer Case Skid Plate

SKU: 558067

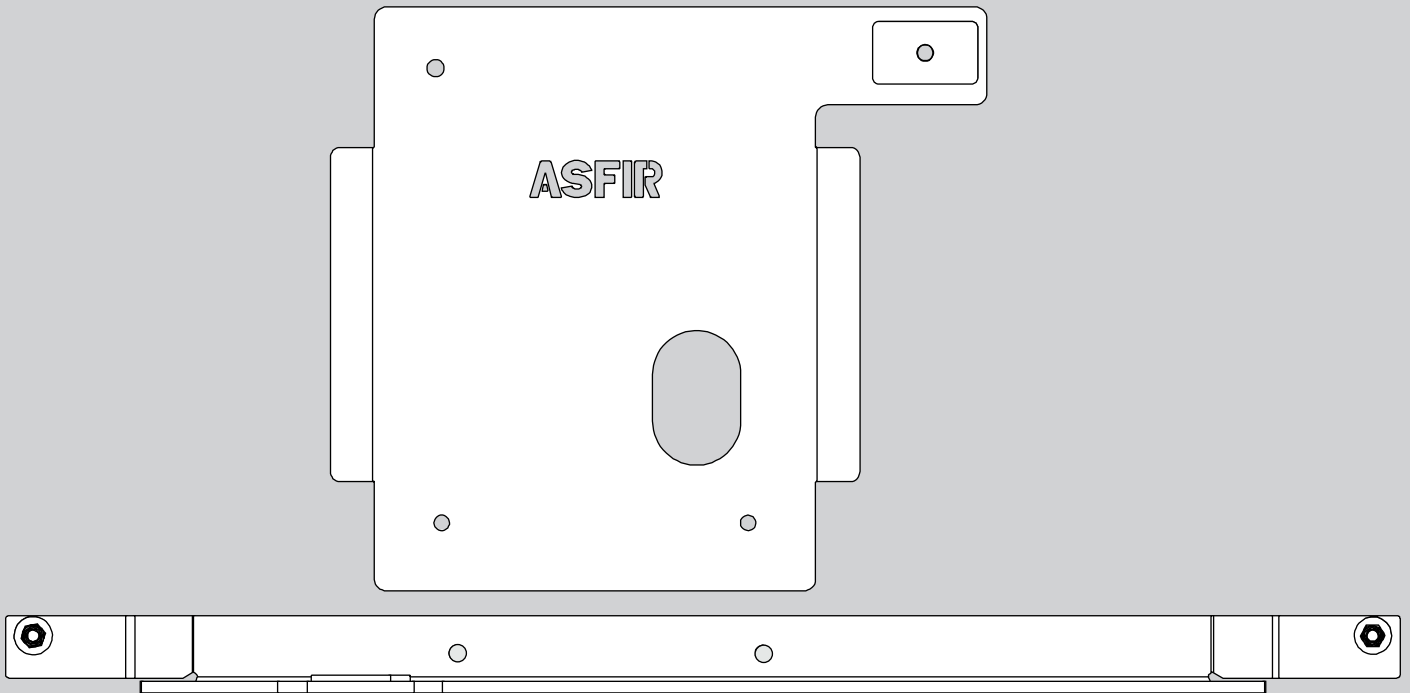

Product drawing:

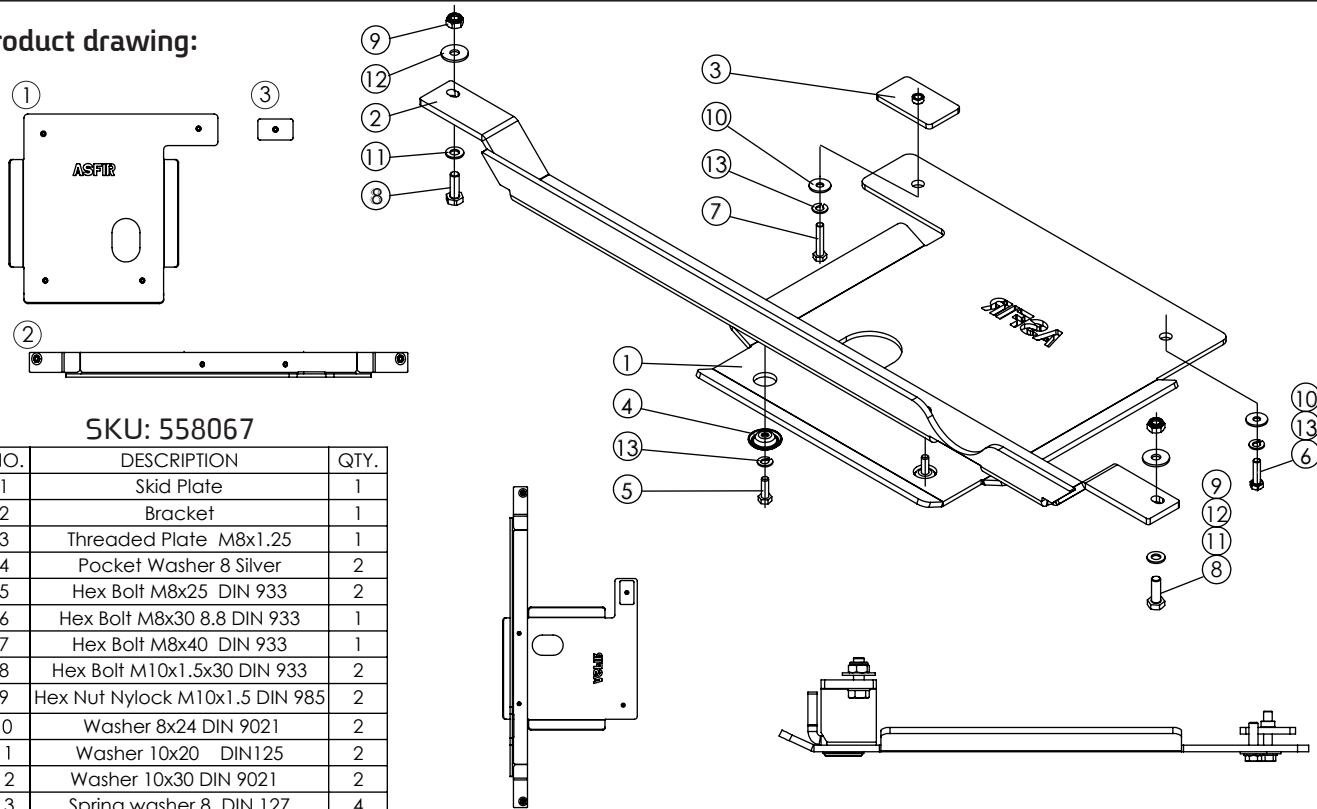

SKU: 558067

NO.	DESCRIPTION	QTY.
1	Skid Plate	1
2	Bracket	1
3	Threaded Plate M8x1.25	1
4	Pocket Washer 8 Silver	2
5	Hex Bolt M8x25 DIN 933	2
6	Hex Bolt M8x30 8.8 DIN 933	1
7	Hex Bolt M8x40 DIN 933	1
8	Hex Bolt M10x1.5x30 DIN 933	2
9	Hex Nut Nylock M10x1.5 DIN 985	2
10	Washer 8x24 DIN 9021	2
11	Washer 10x20 DIN 125	2
12	Washer 10x30 DIN 9021	2
13	Spring washer 8 DIN 127	4

Parts display:

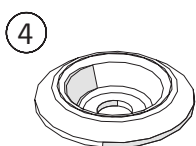

Pocket Washer 8
Silver
x2

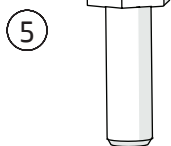

Hex bolt M8x25
x2

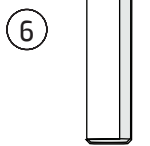

Hex bolt M8x30
x1

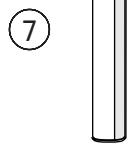

Hex bolt M8x40
x1

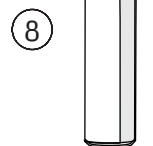

Hex bolt
M10X1.5X30
x2

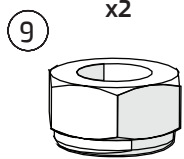

Hex Nut nylock
M10X1.5
x2

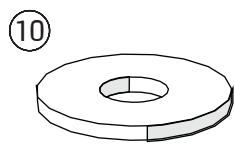

Washer 8X24
x2

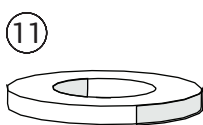

Washer 10x20
x2

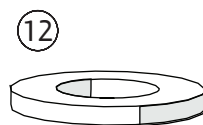

Washer 10x30
x2

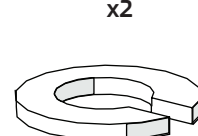

Spring Washer 8
x4

Tools needed:

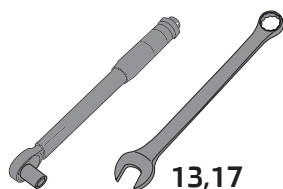

13,17

Maximum Tightening Torques

M8 (8.8)	25 Nm
M10 (8.8)	50 Nm

Safety recommendation: work goggles & gloves



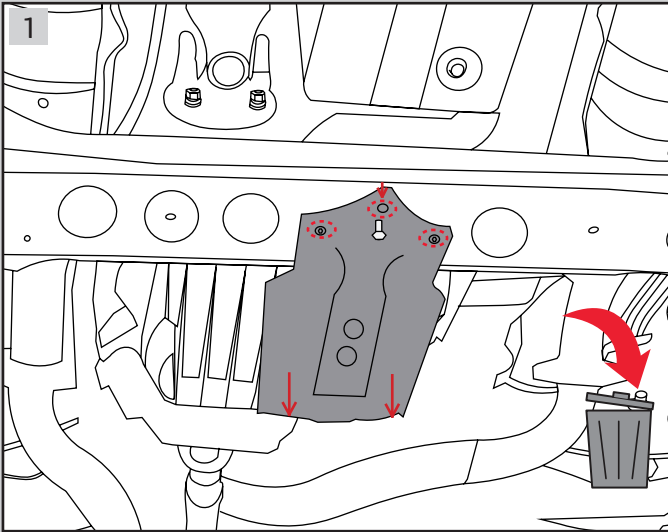

Remove the original Transmission cover and bolts they are not needed

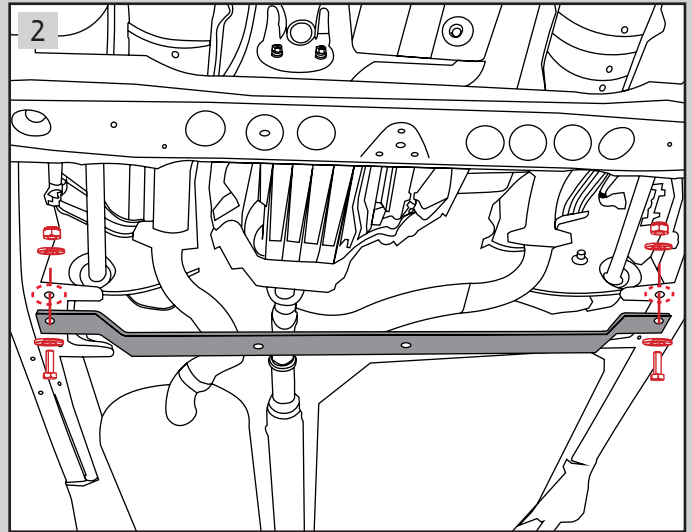

Insert the bracket to these holes by using: 2 M10X1.5X30 HEX BOLTS, 2 10X20 WASHERS, 2 10X30 WASHERS, and 2 M10X1.5 Hex Nut nylock

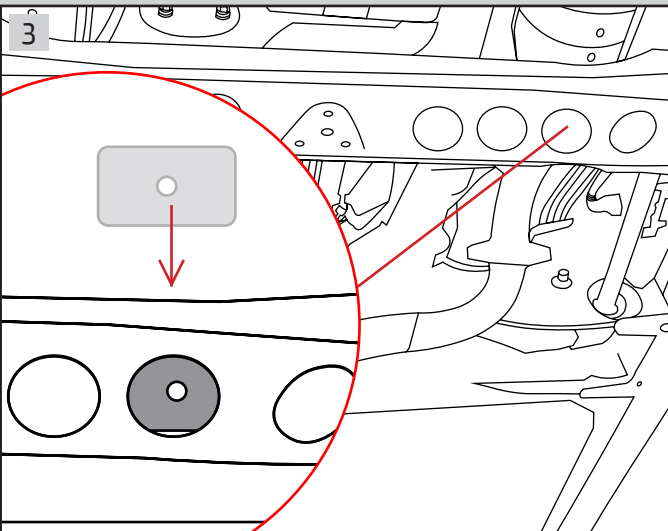

Insert the threaded plate inside this crossmember hole

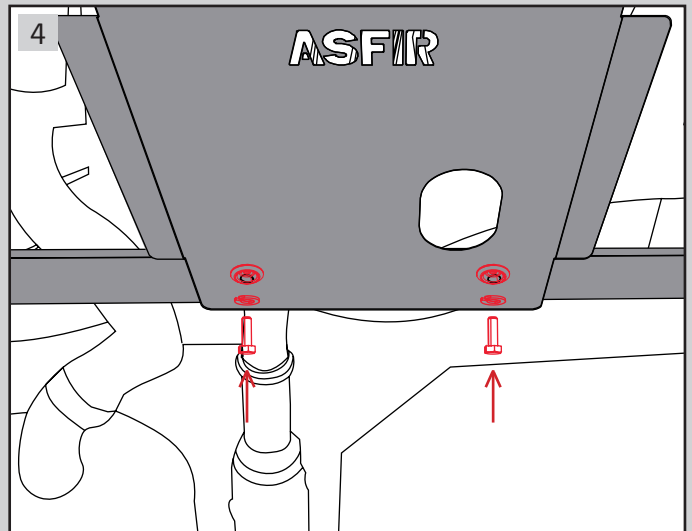

Insert 2 Hex bolt M8X25 bolts, 2 Spring Washer 8, 2 Pocket Washer 8 Silver,

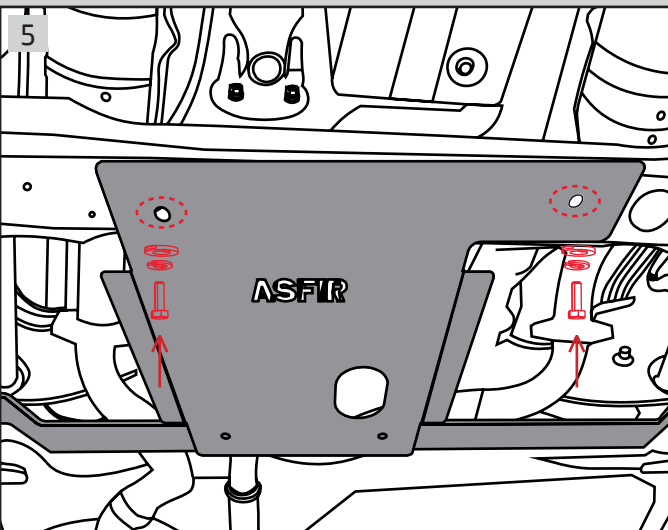

Insert 8X24 washer, spring washer, Hex bolt M8x30 into the left hole, and insert 8X24 washer, spring washer, Hex bolt M8x40 into the right hole. (in case of installing gear protection as well skip this step)

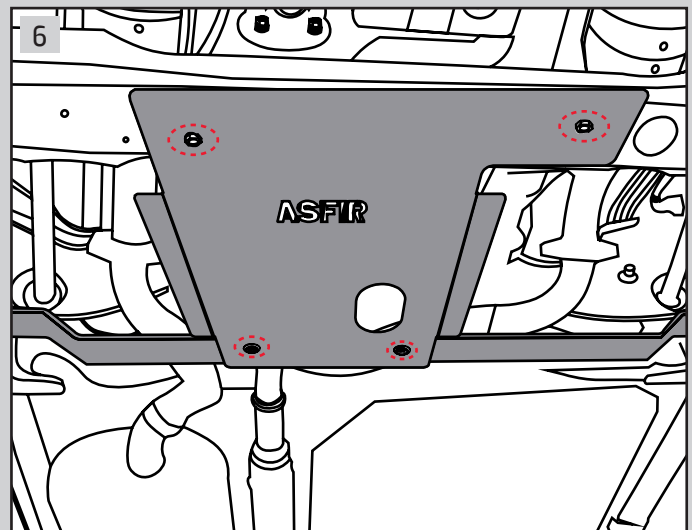

Tighten all the bolts according to the required torque